

## SD9629ET OVERVIEW

The SD9629ET is a single-channel, 12-bit, analog-to-digital converter (ADC) supporting sampling rates up to 40MSps. The SD9629ET supports an extended temperature range of -55°C to 125°C. The device uses a multistage pipeline architecture to achieve high signal-to-noise ratio (SNR) and linearity, over wide input signal bandwidth. The SD9629ET uses a CMOS output interface to transfer the data out. Programming for configuration and control is accomplished using a 3-wire SPI-compatible serial bus. The digital output data can be programmed to be delivered in offset binary, two's complement format, or gray code.

## FEATURES

- Extended temperature range (-55°C to 125°C)
- SNR: 70.6dBFS at  $f_{IN} = 30.2\text{MHz}$  and  $f_S = 40\text{MSps}$
- SFDR: 83.0dBc at  $f_{IN} = 30.2\text{MHz}$  and  $f_S = 40\text{MSps}$
- -144.0dBFS/Hz input-noise at  $f_{IN} = 30.2\text{MHz}$  and  $f_S = 40\text{MSps}$
- 1.8V nominal input
- Typical power consumption: 178mW at 40MSps
- Integer 1-to-8 input clock divider (320MHz maximum input rate)
- Sample rates of up to 40MSps
- 1.8V analog supply voltage
- Up to 3.3V digital I/O supply voltage
- Internal ADC voltage reference
- ADC clock duty cycle correction
- Serial port control
- Energy saving power-down modes

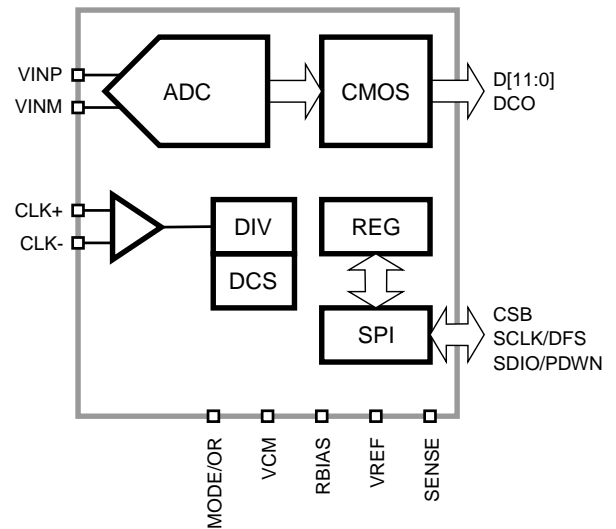

Figure 1: SD9629ET Functional Block Diagram.

## APPLICATIONS

- Communications
- General-purpose software radios
- Data acquisition systems (DAQ)
- Process control Systems
- Smart antenna systems
- Multimode digital receivers
- Ultrasound equipment
- Radar/LiDAR applications

## Table of Contents

SPECIFICATIONS .....	1
DC Specifications .....	1
AC Specifications .....	2
Digital Specification .....	3
Switching Specifications .....	5
Output Timing Control .....	5
ABSOLUTE MAXIMUM RATINGS .....	6
PACKAGE .....	7
TYPICAL PERFORMANCE CHARACTERISTICS .....	9
EQUIVALENT CIRCUITS .....	11
THEORY OF OPERATION .....	12
ADC Architecture .....	12
Stand-by and Power-Down Modes .....	13
Commonly Used Functions .....	13
SERIAL PORT INTERFACE .....	15
OUTPUT MODE .....	17
Data Scrambler .....	17
Alternate Bit Polarity .....	17
Output Test Modes .....	17
CONTROL REGISTERS .....	19
ADC BRING-UP .....	23
Extended Temperature .....	23
ORDERING INFORMATION .....	24
PACKAGE DRAWING .....	25
APPENDIX A: Register Map .....	26
0x400 - CHIP_TOP .....	26
0xF00 - ADC_COMMON .....	29
0xCC1 - ADC .....	31
REVISION HISTORY .....	33

## SPECIFICATIONS

### DC Specifications

At  $T_A = 25^\circ\text{C}$ ,  $V_{AVDD} = 1.8\text{V}$ ,  $V_{DRVDD} = 1.8\text{V}$ ,  $F_{CLK} = 40\text{MHz}$ ,  $A_{IN} = -1\text{dBFS}$ , differential AC-coupled external clock source, unless otherwise noted.

Table 1. DC Specifications.

PARAMETER	TEMP	MIN	TYP	MAX	UNIT
Resolution			12		bits
Accuracy					
No Missing Codes	Full		Guaranteed		
Offset Error	Full	-0.50		0.50	%FSR
Gain Error	Full	-4.25		0.75	%FSR
DNL	Full			$\pm 0.6$	LSB
INL	Full			$\pm 0.9$	LSB
Matching					
Offset Error	25°C	-0.70		0.70	%FSR
Gain Error	25°C	-0.40		0.40	%FSR
Temperature Drift					
Offset Error	Full		0.1		ppm/°C
Gain Error	Full		80.0		ppm/°C
Internal Voltage Reference					
Output Voltage	Full	0.99		1.05	V
External Voltage Reference					
Range	Full	0.90		1.07	V
Input Referred Noise					
$V_{REF} = 1.0\text{V}$	25°C		0.41		LSB(rms)
Analog Input					
Input Span, $V_{REF} = 1.0\text{V}$	Full		1.8		V
Input Capacitance	Full		6.0		pF
Input Resistance	Full		2.0		k $\Omega$
Input Common-Mode Voltage	Full		0.70		V
Input Common-Mode Range	Full	0.65		0.75	V
VCM Voltage	Full		0.70		V
VCM Current Capability	Full		100		$\mu\text{A}$
Reference Input Resistance	Full		50		k $\Omega$
Power Supply					
$V_{AVDD}$	Full	1.7	1.8	1.9	V
$V_{DRVDD}$ (CMOS)	Full	1.7	1.8	3.6	V
$I_{AVDD} @ 1.8\text{V}$	Full		95	120	mA
$I_{DRVDD} @ 1.8\text{V}$	Full		4	5	mA
Power Consumption					
Sine Wave Input	Full		178		mW
Stand-by <sup>1</sup>	Full		60		mW
Power Down	Full		10.0		mW

<sup>1</sup> Stand-by power is measured with a sinewave input and active clock.

## AC Specifications

At  $T_A = 25^\circ\text{C}$ ,  $V_{AVDD} = 1.8\text{V}$ ,  $V_{DRVDD} = 1.8\text{V}$ ,  $F_{CLK} = 40\text{MHz}$ ,  $A_{IN} = -1\text{dBFS}$ , differential AC-coupled external clock source, High-Performance Calibration Mode enabled, background calibration enabled, unless otherwise noted.

Table 2. AC Performance Specifications.

PARAMETER	TEMP	MIN	TYP	MAX	UNIT
Signal-to-Noise Ratio (SNR)					
$f_{IN} = 6.55\text{MHz}$	$25^\circ\text{C}$		70.8		dBFS
$f_{IN} = 30.2\text{MHz}$	$25^\circ\text{C}$		70.6		dBFS
	Full	69.6			dBFS
$f_{IN} = 70.2\text{MHz}$	$25^\circ\text{C}$		70.3		dBFS
$f_{IN} = 220\text{MHz}$	$25^\circ\text{C}$		68.4		dBFS
Signal-to-Noise and Distortion Ratio (SNDR)					
$f_{IN} = 6.55\text{MHz}$	$25^\circ\text{C}$		70.6		dBFS
$f_{IN} = 30.2\text{MHz}$	$25^\circ\text{C}$		70.4		dBFS
	Full	69.3			dBFS
$f_{IN} = 70.2\text{MHz}$	$25^\circ\text{C}$		70.2		dBFS
$f_{IN} = 220\text{MHz}$	$25^\circ\text{C}$		68.1		dBFS
Effective Number of Bits (ENOB)					
$f_{IN} = 6.55\text{MHz}$	$25^\circ\text{C}$		11.4		bits
$f_{IN} = 30.2\text{MHz}$	$25^\circ\text{C}$		11.4		bits
$f_{IN} = 70.2\text{MHz}$	$25^\circ\text{C}$		11.4		bits
$f_{IN} = 220\text{MHz}$	$25^\circ\text{C}$		11.0		bits
Worst 2 <sup>nd</sup> or 3 <sup>rd</sup> Harmonic Power					
$f_{IN} = 6.55\text{MHz}$	$25^\circ\text{C}$		-89.0		dBc
$f_{IN} = 30.2\text{MHz}$	$25^\circ\text{C}$		-89.0	-85.0	dBc
$f_{IN} = 70.2\text{MHz}$	$25^\circ\text{C}$		-89.0		dBc
$f_{IN} = 220\text{MHz}$	$25^\circ\text{C}$		-82.0		dBc
Worst Non-Harmonic Power					
$f_{IN} = 6.55\text{MHz}$	$25^\circ\text{C}$		-88.0		dBc
$f_{IN} = 30.2\text{MHz}$	$25^\circ\text{C}$		-85.0		dBc
$f_{IN} = 70.2\text{MHz}$	$25^\circ\text{C}$		-85.0		dBc
$f_{IN} = 220\text{MHz}$	$25^\circ\text{C}$		-81.0		dBc
Spurious-Free Dynamic Range <sup>1</sup> (SFDR)					
$f_{IN} = 6.55\text{MHz}$	$25^\circ\text{C}$		86.0		dBc
$f_{IN} = 30.2\text{MHz}$	$25^\circ\text{C}$		83.0		dBc
	Full	78.0			dBc
$f_{IN} = 70.2\text{MHz}$	$25^\circ\text{C}$		83.0		dBc
$f_{IN} = 220\text{MHz}$	$25^\circ\text{C}$		79.0		dBc
Two-Tone SFDR					
$f_{IN1} = 29.1\text{MHz}$ , $f_{IN2} = 30.6\text{MHz}$	$25^\circ\text{C}$		84.5		dBc
Analog Input Bandwidth	Full		650.0		MHz

<sup>1</sup> SNR, SNDR and SFDR exclude the DC and  $f_s/2$  bins.

## Digital Specification

$V_{AVDD} = 1.8V$ ,  $V_{DRVDD} = 1.8V$ ,  $F_{CLK} = 40MHz$ ,  $A_{IN} = -1dBFS$ , differential AC-coupled external clock source, DCS disabled, unless otherwise noted.

Table 3. Differential Clock Input.

PARAMETER	TEMP	MIN	TYP	MAX	UNIT
Logic Compliance	Full	CMOS/LVDS/LVPECL			
Internal Common-Mode Bias	Full		0.9		V
Differential Input Voltage	Full	0.3		1.2	$V_{p-p}$
Input Voltage Range	Full	$V_{AGND}-0.3$		$V_{AVDD}+0.2$	V
Input Common-Mode Range	Full	0.75		1.05	V
High Level Input Current	Full	-10		10	$\mu A$
Low Level Input Current	Full	-10		10	$\mu A$
Input Capacitance	Full		1.7		pF
Input Resistance	Full		6.0		k $\Omega$

Table 4. CSB Input.

PARAMETER	TEMP	MIN	TYP	MAX	UNIT
High Level Input Voltage	Full	1.22			V
Low Level Input Voltage	Full			0.6	V
High Level Input Current	Full	-1		1	$\mu A$
Low Level Input Current	Full	-1		1	$\mu A$
Input Capacitance	Full		1.5		pF
Input Resistance	Full		100		k $\Omega$

Table 5. SCLK/DFS Input.

PARAMETER	TEMP	MIN	TYP	MAX	UNIT
High Level Input Voltage	Full	1.22			V
Low Level Input Voltage	Full			0.6	V
High Level Input Current	Full	-1		1	$\mu A$
Low Level Input Current	Full	-1		1	$\mu A$
Input Capacitance	Full		1.5		pF
Input Resistance	Full		100		k $\Omega$

Table 6. SDIO/PDWN Input.

PARAMETER	TEMP	MIN	TYP	MAX	UNIT
High Level Input Voltage	Full	1.22			V
Low Level Input Voltage	Full			0.6	V
High Level Input Current	Full	-1		1	$\mu A$
Low Level Input Current	Full	-1		1	$\mu A$
Input Capacitance	Full		1.5		pF
Input Resistance	Full		100		k $\Omega$

Table 7. CMOS Outputs (DATA and OR).

PARAMETER	TEMP	MIN	TYP	MAX	UNIT
DRVDD = 3.3V					
High Level Output Voltage @50 $\mu$ A	Full	3.20			V
High Level Output Voltage @0.5mA	Full	3.10			V
Low Level Output Voltage @50 $\mu$ A	Full			0.05	V
Low Level Output Voltage @1.6mA	Full			0.10	V
DRVDD = 1.8V					
High Level Output Voltage @50 $\mu$ A	Full	1.77			V
High Level Output Voltage @0.5mA	Full	1.75			V
Low Level Output Voltage @50 $\mu$ A	Full			0.05	V
Low Level Output Voltage @1.6mA	Full			0.10	V

## Switching Specifications

$V_{AVDD} = 1.8V$ ,  $V_{DRVDD} = 1.8V$ ,  $F_{CLK} = 40MHz$ ,  $A_{IN} = -1dBFS$ , differential AC-coupled sine wave external clock source, DCS enabled, unless otherwise noted.

Table 8. Clock Input Timing.

PARAMETER	TEMP	MIN	TYP	MAX	UNIT
Input Clock Rate	Full			320	MHz
Conversion Rate (after clock divider)	Full	3.0		40.0	MHz
<i>CLK Pulse Width High (<math>t_{CH}</math>)</i>					
Divide-by-1 Mode, DCS Enabled	Full	1.5			ns
Divide-by-1 Mode, DCS Disabled	Full	11.0	12.5	14.0	ns
Divide-by-2 Mode Through Divide-by-8 Mode	Full	1.5			ns
Aperture Delay ( $t_A$ )	Full		0.5		ns
Aperture Uncertainty (Jitter, $t_J$ )	Full		140.0		fs

Table 9. Data Output.

PARAMETER	TEMP	MIN	TYP	MAX	UNIT
Data Propagation Delay ( $t_{PD}$ )	Full		6.0		ns
DCO Propagation Delay ( $t_{DCO}$ )	Full		7.0		ns
DCO to Data Skew ( $t_{SKEW}$ )	Full	0.3	1.2	2.2	ns
Pipeline Delay (Latency, L)	Full		35.0		Cycles
Wake-Up Time (from sleep)	Full		5.0		$\mu s$
Wake-Up Time (from power down)	Full		500.0		$\mu s$
Out-of-Range Recovery Time	Full		3		Cycles

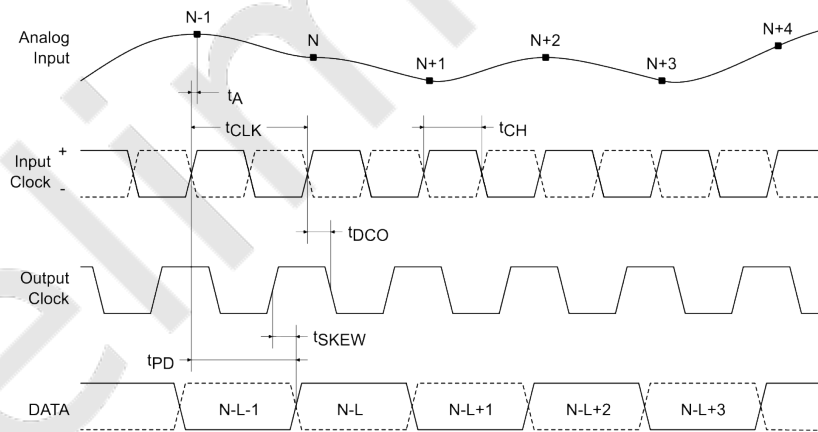

Figure 2: Parallel CMOS Output Mode Timing.

## Output Timing Control

Data delay control, bits [8:5], in register  $0x473$ , can be used to move the CMOS data relative to output clock. Bit [9] inverts the internal clock sending the data out. Bits [13:10], in register  $0x473$ , control the output clock delay relative to output data, while bit [14] inverts the clock. The delay step size is about 250ps.

Driving long traces or large load capacitance with CMOS output produces voltage ripple in the digital IO supply and ground, which may couple on chip to the sensitive analog circuits in the ADC and degrade the performance. This effect can be reduced by using an external buffer IC.

## ABSOLUTE MAXIMUM RATINGS

Table 10. Absolute Maximum Ratings ( $T_A = 25^\circ\text{C}$ , unless otherwise specified).

Parameter	Symbol	Conditions	Min	Max	Units
AVDD	$V_{AVDD}$	Relative to AGND	-0.3	2.0	V
DRVDD	$V_{DRVDD}$	Relative to AGND	-0.3	3.8	V
VINP, VINM		Relative to AGND	-0.3	2.0	V
CLK+, CLK-		Relative to AGND	-0.3	2.0	V
RBIAS		Relative to AGND	-0.3	2.0	V
SENSE		Relative to AGND	-0.3	2.0	V
VCM		Relative to AGND	-0.3	2.0	V
VREF		Relative to AGND	-0.3	2.0	V
CSB		Relative to AGND	-0.3	3.8	V
SCLK/DFS		Relative to AGND	-0.3	3.8	V
SDIO/PDWN		Relative to AGND	-0.3	3.8	V
MODE/OR		Relative to AGND	-0.3	3.8	V
D0, ..., D11		Relative to AGND	-0.3	3.8	V
DCO		Relative to AGND	-0.3	3.8	V
Operating Temperature Range (Ambient)			-55	125	°C
Maximum Junction Temperature Under Bias				125	
Storage Temperature Range (Ambient)			-65	150	

### Notes:

- Stresses beyond those listed under Table 10 may cause permanent damage to the device. These are stress ratings only and functional operation of the device at these or any other conditions beyond those indicated under recommended operating conditions is not implied. Exposure to absolute-maximum-rated conditions for extended periods may affect device reliability.
- The device passed product qualification in accordance with JESD47. Specifically, High-Temperature Operating Life (HTOL), qualification in accordance with JESD22-A108 testing was performed at a junction temperature of  $T_j = 125^\circ\text{C}$  for 1000 hours across three independent production lots, with sample size of 77 units per lot (231 units total). No failures were observed during full qualification, demonstrating compliance with industry reliability requirements.

### ESD CAUTION.

	<p><b>Electrostatic Discharge Sensitive Device.</b></p> <p>Proper ESD precautions should be observed to prevent performance degradation or loss of functionality.</p>
---	---

**PACKAGE**

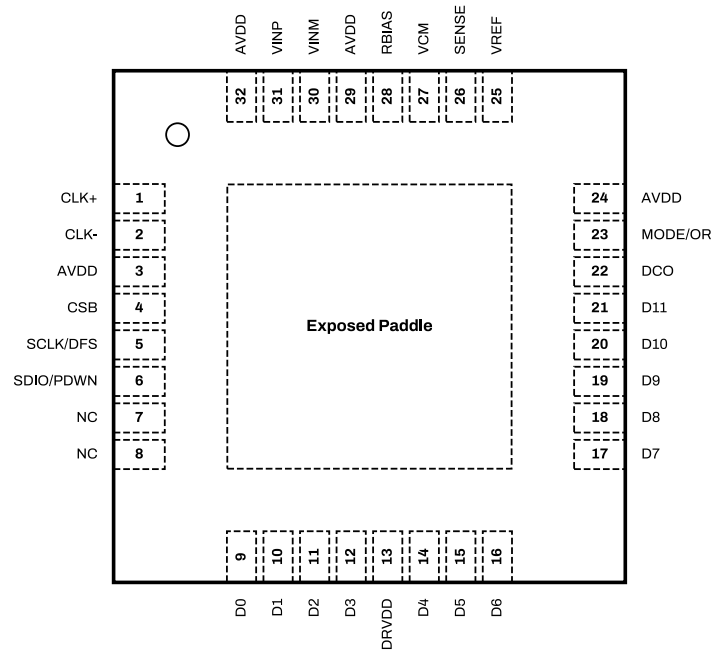

Figure 3: SD9629ET Package Top View.

1. The exposed thermal pad on the bottom of the package provides the analog ground for the part and must be connected for proper operation.

Table 11. Pin Descriptions.

Number	Name	Type	Comment
0	AGND	Ground	Exposed Paddle, Analog Ground.
1	CLK+	Input	ADC Clock Input (Plus).
2	CLK-	Input	ADC Clock Input (Minus).
3, 24, 29, 32	AVDD	Power	Analog Power Supply (1.8 V Nominal).
4	CSB	Input	SPI Chip Select (Active Low).
5	SCLK/DFS	Input	SPI Serial Clock/Data Format Select Pin in External Pin Mode.
6	SDIO/PDWN	InOut	SPI Serial Data I/O. Power Down Pin in External Pin Mode.
7, 8	NC		Do Not Connect.
9	D0	Output	Output Data 0.
10	D1	Output	Output Data 1.
11	D2	Output	Output Data 2.
12	D3	Output	Output Data 3.
13	DRVDD	Power	Digital I/O Supply.
14	D4	Output	Output Data 4.
15	D5	Output	Output Data 5.
16	D6	Output	Output Data 6.
17	D7	Output	Output Data 7.
18	D8	Output	Output Data 8.

Number	Name	Type	Comment
19	D9	Output	Output Data 9.
20	D10	Output	Output Data 10.
21	D11	Output	Output Data 11.
22	DCO	Output	Clock Output.
23	MODE/OR	InOut	Chip Mode Select Input (MODE)/Out-of-Range Digital Output in SPI Mode (OR).
25	VREF	InOut	Voltage Reference Input/Output.
26	SENSE	Input	Reference Programming Pin.
27	VCM	Output	This pin outputs the common-mode voltage that can be used externally to bias the analog input pins.
28	RBIAS	InOut	External Reference Bias Resistor. Connect to 30kΩ (1% tolerance) resistor to ground.
30	VINM	Input	Differential Analog Input Pin (Minus).
31	VINP	Input	Differential Analog Input Pin (Plus).

## TYPICAL PERFORMANCE CHARACTERISTICS

At  $T_A = 25^\circ\text{C}$ ,  $V_{AVDD} = 1.8\text{V}$ ,  $V_{DRVDD} = 1.8\text{V}$ ,  $F_{CLK} = 40\text{MHz}$ ,  $A_{IN} = -1\text{dBFS}$ , differential AC-coupled clock source, High-Performance Calibration Mode enabled, background calibration enabled, unless otherwise noted.

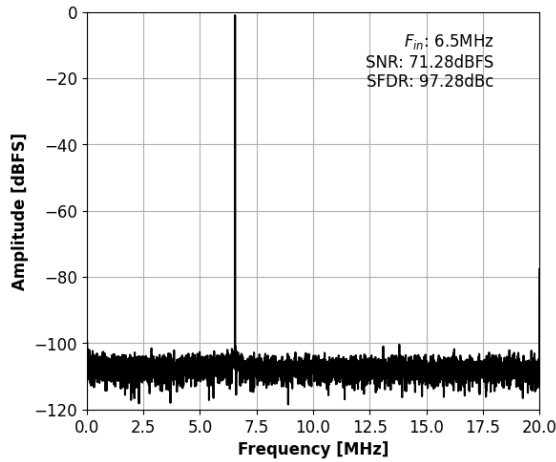

Figure 4: Single-Tone FFT with  $f_{IN}=6.55\text{MHz}$ .

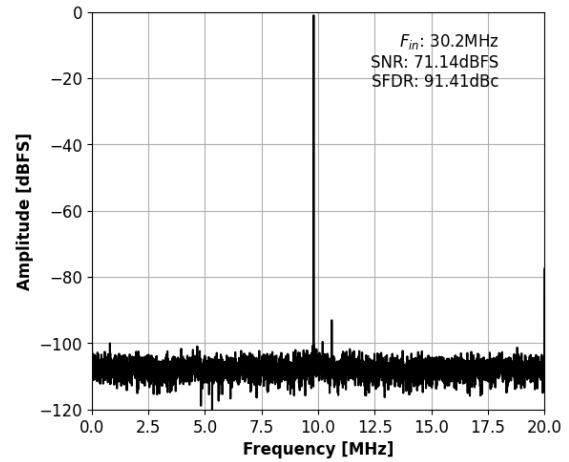

Figure 5: Single-Tone FFT with  $f_{IN}=30.2\text{MHz}$ .

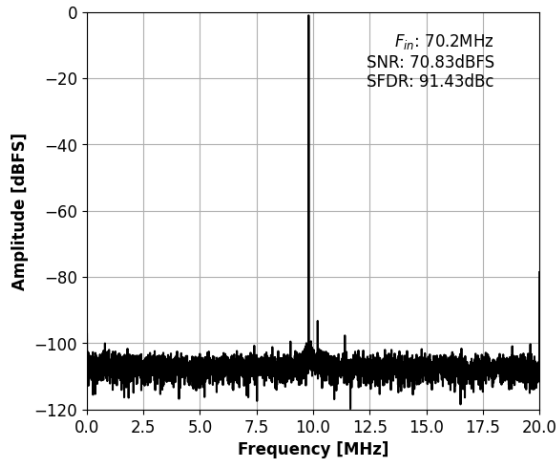

Figure 6: Single-Tone FFT with  $f_{IN}=70.2\text{MHz}$ .

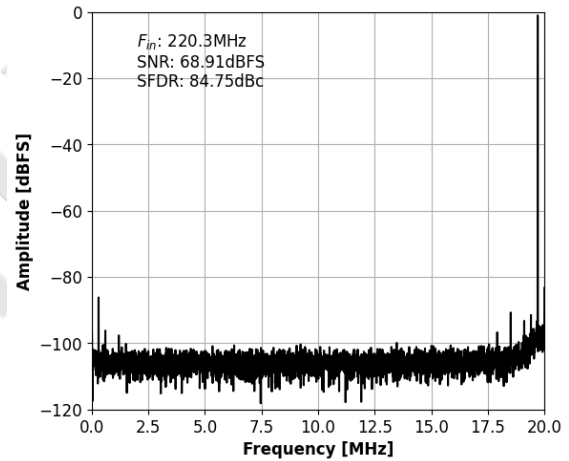

Figure 7: Single-Tone FFT with  $f_{IN}=220\text{MHz}$ .

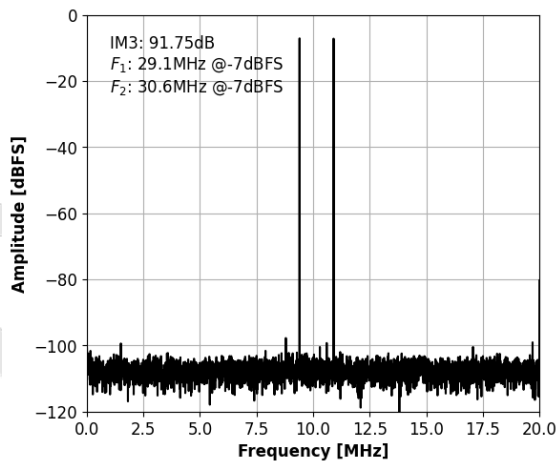

Figure 8: Two-Tone FFT with  $f_{IN1}=29.1\text{MHz}$ ,  $f_{IN2}=30.6\text{MHz}$ .

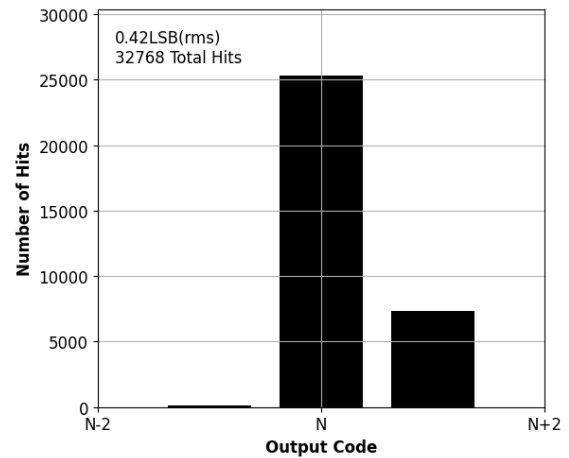

Figure 9: Grounded Input Histogram.

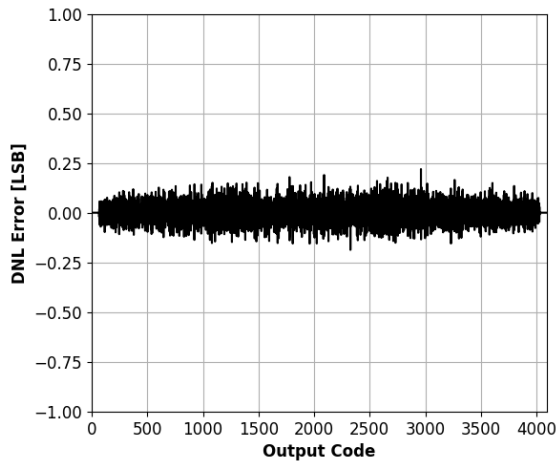

Figure 10: DNL Error with  $f_{IN}=6.55\text{MHz}$ .

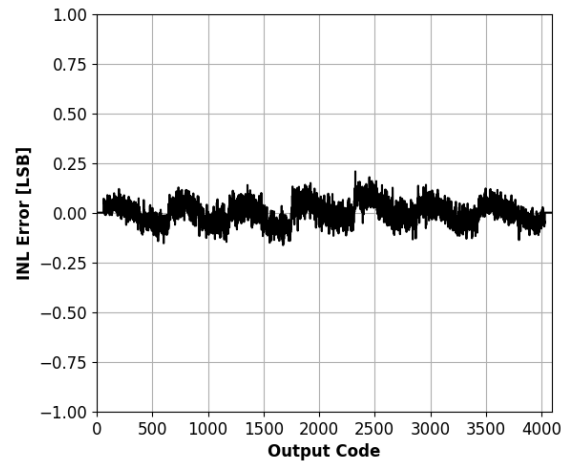

Figure 11: INL Error with  $f_{IN}=6.55\text{MHz}$ .

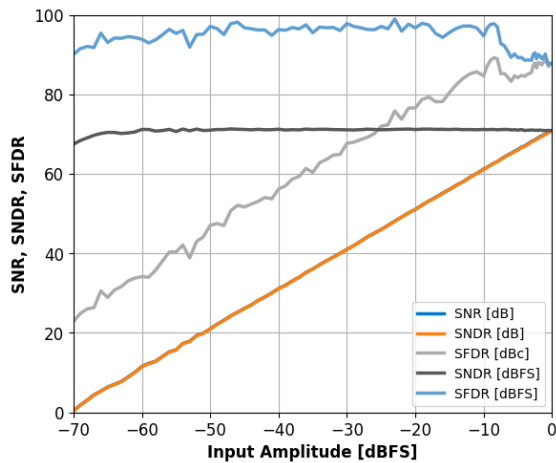

Figure 12: Single-Tone SNR, SNDR and SFDR vs. Input Amplitude with  $f_{IN}=30.25\text{MHz}$ .

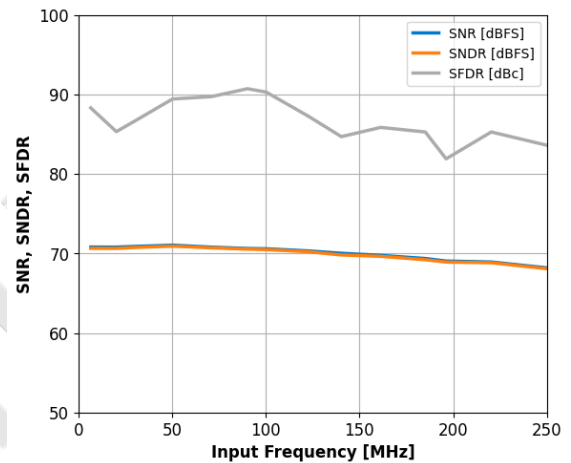

Figure 13: Single-Tone SNR, SNDR and SFDR vs. Input Frequency with  $f_S=40\text{MHz}$ .

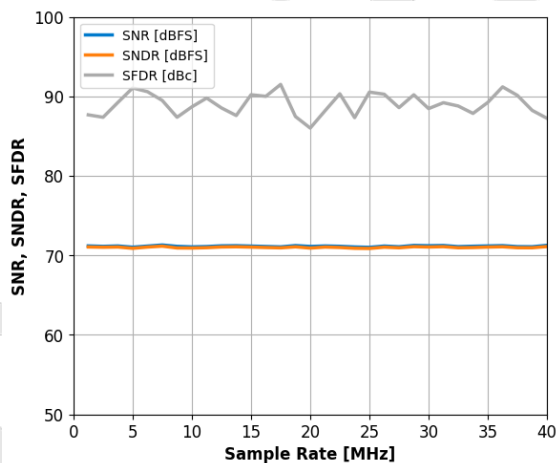

Figure 14: Single-Tone SNR, SNDR and SFDR vs. Sample Rate with  $f_{IN}=30.25\text{MHz}$ .

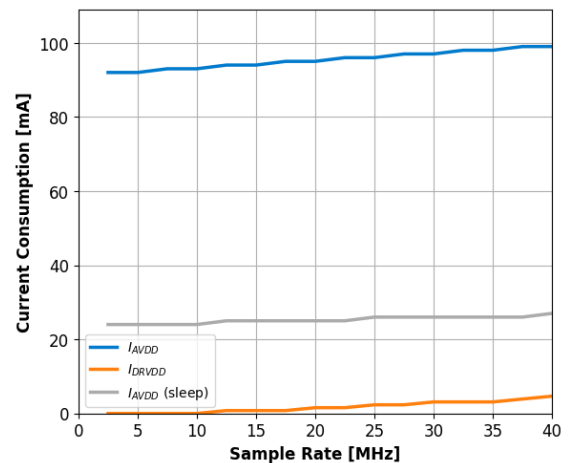

Figure 15: Current vs. Sample Rate.

**EQUIVALENT CIRCUITS**

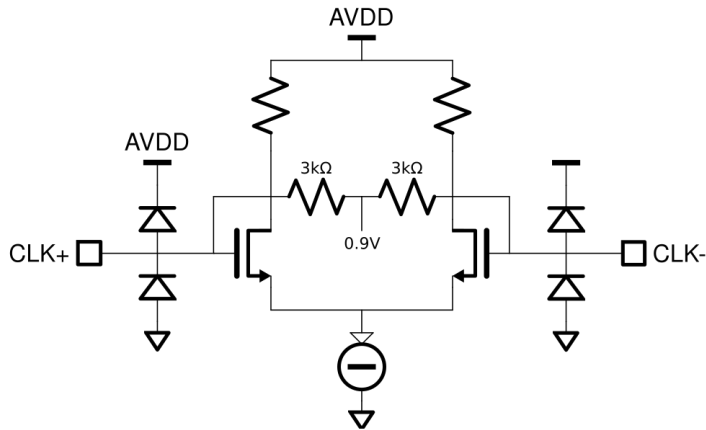

Figure 16: Equivalent Clock Input Circuit.

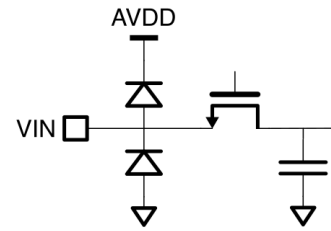

Figure 17: Equivalent Analog Input Circuit.

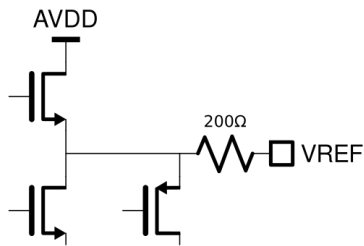

Figure 18: Equivalent VREF Circuit.

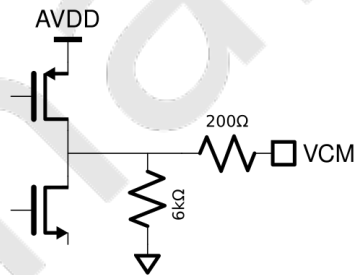

Figure 19: Equivalent VCM Circuit.

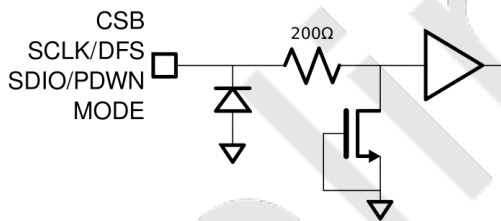

Figure 20: Equivalent CSB, SCLK/DFS, SDIO/PDWN or MODE Input Circuit.

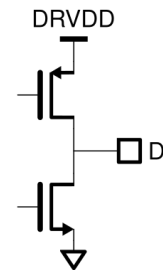

Figure 21: Equivalent Digital Output Circuit.

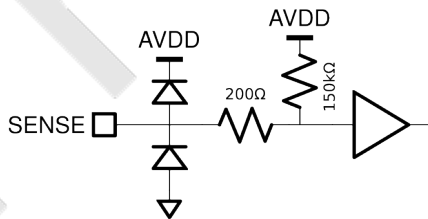

Figure 22: Equivalent SENSE Input Circuit.

## THEORY OF OPERATION

### ADC Architecture

The ADC uses a pipelined architecture and innovative patented switched-capacitor circuits. Its fully differential design provides exceptional immunity to power supply noise and minimizes reference voltage self-modulation. A built-in Sample-and-Hold (S/H) function is integrated into the input stage of the pipeline structure.

### Analog Input

The input stage of the ADC behaves as a switched-capacitor network, presenting itself to the driving circuit as a combination of a switch and a sampling capacitor. The capacitor is reset prior to each conversion cycle, effectively eliminating non-linear memory effects commonly observed in some pipelined ADC architectures. The ADC does not include an internal common-mode bias therefore, the driving source must provide an appropriate common-mode voltage.

### Differential Clock Input

The SD9629ET features a differential clock receiver with an integrated common-mode bias. For proper operation, the clock inputs should be AC-coupled using 10nF capacitors.

**Differential Clock Configuration.** For optimal jitter performance, a differential clock source is recommended. The differential clock signals to CLK+ and CLK- should be connected through a 10nF AC-coupling capacitors.

**Single-Ended Clock Configuration.** If a single-ended clock source is used, the signal source should be AC-coupled to the CLK+ pin. In this configuration, a 10nF capacitor should be connected between the CLK- pin and analog ground to maintain proper biasing.

**Clock Jitter Considerations.** Clock jitter has a significant impact on the ADC's signal-to-noise ratio (SNR). The sensitivity to jitter increases with input signal frequency. For best performance, a low-noise differential clock with fast edge transitions should be used.

**Note:** The part can enter in manufacturing test mode if both differential clock inputs are held low for more than 1ms. This behavior can be prevented by writing 1 to register `0x4cf`, bit[15].

### Clock Divider

The ADC includes a programmable clock divider that allows the input clock to be divided by integer values from 2 to 8. The divider is configured by setting register `0x463`, bits [7:5], to the desired division value. A value of 0 (default) bypasses the divider entirely.

By default, the divider starts asynchronously.

**Clock Duty-Cycle Requirements.** The ADC utilizes both the rising and falling edges of the input clock (or the divided clock, if the divider is enabled) for internal sampling operations. To achieve optimal performance, especially at the maximum sampling rate, the clock duty cycle should be as close to 50% as possible.

When the divider is enabled with an even divisor, a 50% duty cycle is guaranteed by design. If the application uses a clock with a non-ideal duty cycle, a Duty Cycle Stabilizer (DCS) can be enabled to improve performance.

### ADC Self-Calibration

The ADC includes an automatic calibration mechanism that is executed at power-up to ensure optimal performance. It calibrates out capacitor mismatch and the effects of operational amplifier finite gain and bandwidth. For best results, calibration should be performed at the actual sampling rate used during operation. To support this, the device continuously monitors the sampling clock frequency and automatically re-triggers calibration if a significant change is detected. This feature can be disabled by setting register `0x4c9`, bit[0], to 1.

Manual calibration can also be initiated by toggling `0xcc1`, bit[4], from 0 to 1. The calibration process is implemented using a state-machine architecture, ensuring a deterministic and predictable calibration time. By default the calibration takes 46

million ADC sampling clock cycles. Calibration completion status can be read from `0xcef`, bit[0], after the status readback is enabled by writing `0x1c` to `0xceb`. Bit value 1 indicates that calibration is complete.

In addition, the ADC supports a Background Calibration (BGC) mode, which is disabled by default. When enabled, parameters for compensating changes in operational amplifier gain and bandwidth are continuously updated. BGC is beneficial in environments with large temperature variations near the hot end of the specified operating temperature range. For its operation, BGC uses a dither signal which is injected into the ADC input signal path. This dither consumes approximately 0.8dB of the ADC's input range, resulting in earlier clipping compared to when BGC is disabled. When BGC is enabled calibration completion status bit remains 0.

To enable BGC:

- Write `0b01` to register `0xce1`, bits [15:14]
- Write `0b0` to register `0xce3`, bit [3]
- Write `0x0d80` to register `0xccf`

Calibration parameters can be altered to optimize ADC performance and the duration of the calibration according to Table 12. High Performance settings improve the low frequency SFDR compared to the default settings while the High Speed Settings minimize the calibration time at the cost of small SFDR and SNDR degradation. If the parameters are altered, the calibration has to be reinitiated as described earlier.

Table 12. Calibration Settings.

Register Address	Default Value	High Performance Value	High Speed Value
<code>0xccd</code>	<code>0x1483</code>	<code>0x3483</code>	<code>0x348c</code>
<code>0xcd5</code>	<code>0x1483</code>	<code>0x3483</code>	<code>0x348c</code>
<code>0xcd</code>	<code>0x16c3</code>	<code>0x36c3</code>	<code>0x36cc</code>
<code>0xce1</code>	<code>0xbbe8</code>	<code>0xbb80</code>	<code>0xbb20</code>
Duration (clock cycles)	46M	25M	6.3M

## Stand-by and Power-Down Modes

The SD9629ET supports two power-saving modes, power down and stand-by, that can be used when the ADC is not actively sampling. In both modes, the SPI interface (if enabled) remains operational.

**Power-Down Mode.** This mode disables most of the internal circuitry, resulting in the lowest residual supply current. It is ideal for applications requiring minimal power consumption during idle periods. Power-down mode can be enabled via either of the following:

- The PDWN pin, or
- Setting register `0x457`, bit[7], to 1.

**Stand-by Mode.** Stand-by mode offers a faster wake-up time compared to power-down mode, at the cost of slightly higher residual current. It is suitable for applications that require rapid recovery from idle states. To enable stand-by mode, set register `0x457`, bits [3] and [8], to 1.

**Note:** It is recommended to disable the ADC auto-calibration when using stand-by mode to avoid unintended calibration cycles during transitions.

## Commonly Used Functions

The SD9629ET offers several functions available via dual function pin controls (external pin mode vs. SPI mode). The SD9629ET detects the SPI mode during the first SPI transaction after power-up. If the user does not want to program the device via the SPI interface, the dual function is available.

**Duty-Cycle Stabilizer.** The Duty-Cycle Stabilizer (DCS) retimes the falling edge of the clock thus providing an internal clock signal with a 50% duty cycle. The DCS is useful in systems where the input clock has an uneven duty cycle. It can be

enabled via register control, by setting register *0x457*, bit[1], to 1.

**Data Format Select.** Data Format Select (DFS) can be used to select between offset binary or two's complement when operating in the external pin mode.

**Output Enable** (active-low, **OEB**). The output data drivers can be placed in a high-impedance state using the OEB function, accessed by setting register *0x457*, bit[3], to 1.

**External Reference Bias Resistor.** The SD9629ET requires a 30kΩ, 1% resistor, between pin RBIAS and AGND to set the default bias current for the ADC.

**Common-Mode Voltage.** The VCM pin outputs the analog input common-mode bias voltage (VCM). This pin provides a stable DC reference that can be used to set the ADC input common-mode level, either directly through a passive network or indirectly as the common-mode reference for a driving amplifier. In typical applications, the default common-mode voltage is suitable and requires no adjustment. The common-mode voltage level is programmable through register *0xf11*, bits [4:3].

**VREF** The ADC supports both internal (default) and external voltage reference sources, selectable via the VREF pin. The selection between internal and external reference voltage can be made in one of two ways:

- Using the SENSE pin: a logic high level selects the external reference.
- Via register control: setting register *0x45d*, bits [5] and [12] to 1 selects the external reference.

**Internal Reference Output.** When the internal voltage reference is used, the VREF pin can function as a reference output. This output can be enabled by setting register *0x45d*, bits [14:13], to 0x3.

If the SENSE pin is held low, the reference output is enabled by default. To disable the reference output in this configuration, set register *0x45d*, bits [14:13], to 0x1.

The internal vref can be adjusted with *0x45d* bits [4:1]. Usually, the default value yields the optimal performance.

## SERIAL PORT INTERFACE

The SD9629ET uses a 3-wire Serial Port Interface (SPI) that gives the user flexibility to configure the converter for specific functions, depending on the application, through a register space provided inside the ADC. The interface signals are:

- SCLK: defines the bit rate at which serial data is driven onto, and sampled from, the bus;
- CSB: defines the boundaries of a basic data 'unit', comprised of multiple serial bits;
- SDIO: is the serial data IO wire;

The read and write cycles are described in the figure below. The address space is 13 bits long ( $A<12:0>$ ) and the data is 16 bits wide ( $D<15:0>$ ). The complete instruction cycle is 32-bits long. The falling edge of CSB combines with the rising edge of SCLK marks the start of the instruction cycle. On a write transaction, the target register is updated on the falling edge of SCLK.

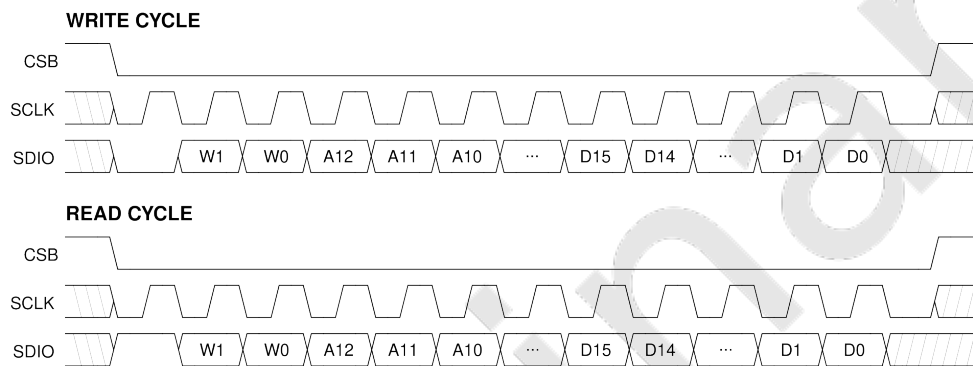

Figure 23: 3-wire SPI timing.

Table 13. SPI Timing.

PARAMETER	TEMP	MIN	TYP	MAX	UNIT
Setup time between the data and the rising edge of SCLK	$t_{DS}$	2			ns
Hold time between the data and the rising edge of SCLK	$t_{HD}$	2			ns
Period of the SCLK	$t_{SCLK}$	40			ns
Setup time between CSB and SCLK	$t_{S,CSB-SCLK}$	2			ns
Hold time between CSB and SCLK	$t_{H,CSB-SCLK}$	2			ns
Minimum period that SCLK should be in a logic high state	$t_{SCLK,high}$	10			ns
Minimum period that SCLK should be in a logic low state	$t_{SCLK,low}$	10			ns
Time from SCLK falling edge to SDIO switching from input to output	$t_{SDIO,EN}$	10			ns
Time from SCLK falling edge to SDIO switching from output to input	$t_{SDIO,DIS}$	10			ns

Two bits, W1 and W0, determine how many bytes of data that can be transferred in the same write cycle (see Table 14). If more than 16 bits (2 Bytes) of data are being transferred the address is increased sequentially.

Table 14. SPI Word Length.

[W1,W0]	Data length
00	Not supported
01	Two bytes of data can be transferred
10	Not supported
11	Four bytes of data can be transferred

The SPI pins should not be active when the full dynamic performance of the ADC is required. Noise from SCLK, CSB and the data transactions can degrade ADC performance.

Preliminary

## OUTPUT MODE

### Data Scrambler

Interference originating from the digital outputs of the ADC can be difficult to eliminate entirely. Such interference may result from capacitive or inductive coupling mechanisms, or from shared impedance paths in the ground plane. Even minimal coupling coefficients can introduce deterministic spurious tones into the ADC's output frequency spectrum. To mitigate this, digital output scrambling techniques can be employed prior to off-chip transmission. By randomizing the bit patterns, the spectral energy of these spurs is dispersed, effectively reducing their peak amplitudes and minimizing their impact on signal integrity.

The SD9629ET can apply an exclusive-OR logic operation between the LSB and all other data output bits, while the LSB, overflow and clock outputs are not affected.



When this function is used, the receiver must apply the same function to unscramble the received data.

The data scrambler is enabled by setting control register  $0x4b5$ , bit[13], to 1.

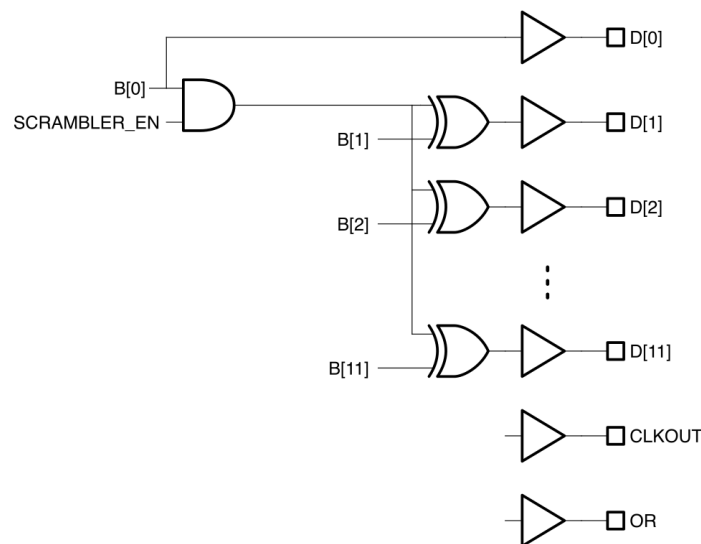

Figure 24: SD9629ET Data Scrambler.

### Alternate Bit Polarity

The alternate bit polarity is particularly effective to suppress digital feedback and minimize noise coupling on the PCB when the ADC input signal is near mid-scale and of very small amplitude. In this case, the digital output tends to toggle between patterns dominated by either logic high or logic low states. This synchronized switching of multiple bits can induce significant transient currents in the ground plane, leading to increased digital noise. This mode, when activated, inverts all odd-numbered data output bits prior to the output buffer stage while even-numbered bits, along with the overflow and clock output, remain unaffected thus ensuring that approximately half of the output bits transition are high while the other half transition are low. This balanced switching behavior helps cancel out opposing current flows in the ground return path, thereby reducing overall ground noise. At the receiving end, the original data can be reconstructed by inverting the same odd-numbered bits. This mode operates independently of the digital output randomization feature, both functions can be enabled or disabled separately. The Alternate Bit Polarity mode is configured via serial programming of control register  $0x4b5$ , bit[14].

### Output Test Modes

The output test options are described in Table 15 and are selected via SPI programming at register  $0x4b5$ , bits [5:2].

When an output test mode is enabled, the analog section of the ADC is disconnected from the digital back-end blocks and the test pattern is run through the output formatting block. These tests require an active input clock.

There are two pseudo-random number generators available, PN23 and PN9. The PN23 generator ( $X^{23}+X^{18}+1$ ), selected by register  $0x4b5$ , bits [5:2], set to 0x5, can be reset by setting register  $0x4b5$ , bit [12], low; while the PN9 generator ( $X^9+X^6+1$ ), selected by register  $0x4b5$  set to 0x6, can be reset by setting register  $0x4b5$ , bit [11], low.

Table 15. Output Test Modes.

Mode	Function
0	Pass-Through
1	Midscale
2	+FS
3	-FS
4	Checkerboard
5	PN23
6	PN9
7	1/0 word toggle
8	User input
9	1/0 bit toggle
10	Unused
11	1-bit high
12	Mixed frequency
13	Unused
14	Unused
15	Ramp

Pass-through and test patterns 1, 2, 3, 5 and 6 are subject to output formatting, while the other test modes are not. Test patterns 1, 8 and 15 can be applied to either one channel or both channels using  $0x4b5$ , bit[7:6]. Patterns 4 and 7 can be toggled between the pattern and its inverse while test pattern 8 can be selected using registers  $[DB\_TEST0\_register]$  and  $[DB\_TEST1\_register]$ .

## CONTROL REGISTERS

This section describes the most commonly used control registers. For a description of the complete register map, refer to Appendix A: Register Map.

Each register is presented in the following format:

Address: <HEX value>		RW or RO	Default: <HEX value>
bit field	default value	field description.	

### Notes

- **RW** = Read/Write
- **RO** = Read-Only
- For read-only registers, the default value is omitted.
- Registers not listed in these tables should not be written.



When updating control register values, always use a read-modify-write procedure. Some registers include reserved bit fields for internal engineering purposes. This approach ensures that these reserved bits remain unchanged and prevents unintended modifications.

### CHIP TOP:

Address: 0x457		RW	Default: 0x0015
[0]	0x1		Duty Cycle Stabilizer enable (see [paragraph_DCS]). 0: Disable 1: Enable
[1]	0x0		Duty Cycle Stabilizer on/off in SPI mode (see [paragraph_DCS]). 0: Off 1: On
[2]	0x1		External output enable (OE/OEB) control (see [paragraph_OEB]). 0: Output Enabled 1: Output depends on pin OE/OEB
[3]	0x0		Output disable (see [paragraph_OEB]). 0: Output depends on OE/OEB control and OE/OEB pin 1: Disabled
[4]	0x1		MODE/OR pin function select 0: MODE 1: OR
[6:5]	0x0		Select MODE/OR pin function in SPI mode 00: Power down (default) 01: Stand-by 10: OE 11: OEB
[7]	0x0		Software power down. 0: Active State 1: Power Down
[8]	0x0		Software stand-by mode. 0: Active State 1: Stand-by Mode

Address: 0x463		RW	Default: 0x0019
[0]	0x1		Enable clock receiver. 0: Disable 1: Enable
[4:1]	0xc		Reserved.
[7:5]	0x0		Clock RX divider control. 0: Bypass 1: Divide by 2 2: Divide by 3 3: Divide by 4 4: Divide by 5 5: Divide by 6 6: Divide by 7 7: Divide by 8
[8]	0x0		Enable on-chip 100Ohm termination. 0: Disable 1: Enable
[9]	0x0		Clock polarity control when DCS is enabled. 0: Disable 1: Invert
[10]	0x0		Reserved.

Address: 0x465		RW	Default: 0x0001
[2:0]	0x1		Output data interleaver. 0-5: N/A 6: even-odd interleaving 7: odd-even interleaving

Address: 0x473		RW	Default: 0x0000
[4:0]	0x0		Reserved.
[9:5]	0x0		Output data delay in parallel CMOS mode. The output data delay is increased by 250ps * (register value) with respect to the clock
[13:10]	0x0		Reserved.
[14]	0x0		Output data sending clock polarity in parallel CMOS mode. 0: Not inverted 1: Inverted
[13:10]	0x0		Output clock delay. The output clock delay is increased by 250ps * (register value) with respect to the data
[14]	0x0		Output clock polarity. 0: Not inverted 1: Inverted

Address: 0x4b5		RW	Default: 0x18c0
[1:0]	0x0		Output format. 0: Offset binary 1: Two's complement 2: Gray code 3: Offset binary
[5:2]	0x0		Output test mode select (see Table 15).
[6]	0x1		Output test channel. 0: Disable 1: Enable
[7]	0x1		Reserved.
[8]	0x0		Output test toggle mode. Toggle between user test pattern 0 and 1.
[10:9]	0x0		Reserved.
[11]	0x1		PN9 generator reset (active low).
[12]	0x1		PN23 generator reset (active low).
[13]	0x0		Enable the output data scrambler. 0: Disable 1: Enable
[14]	0x0		Enable alternate bit polarity switch. 0: Disable 1: Enable

**ADC:**

Address: 0xcc1		RW	Default: 0xbfff
[3:0]	0xf		Reserved.
[4]	0x1		Calibration soft reset (active low).
[15:5]	0x5f9		Reserved.

See Table 12 for valid configurations for the following registers:

Address: 0xccd		RW	Default: 0x1483
[2:0]	0x3		Stg1 calibration convergence speed in foreground mode (see Table 12).
[11:3]	0x90		Reserved.
[13:12]	0x1		Stg1 calibration randomization sequence in foreground mode (see Table 12).

Address: 0xcd5		RW	Default: 0x1483
[2:0]	0x3		Stg2 calibration convergence speed in foreground mode (see Table 12).
[11:3]	0x90		Reserved.
[13:12]	0x1		Stg2 calibration randomization sequence in foreground mode (see Table 12).

Address: 0xcd		RW	Default: 0x16c3
[2:0]	0x3		Stg3 calibration convergence speed in foreground mode (see Table 12).
[11:3]	0xd8		Reserved.
[13:12]	0x1		Stg3 calibration randomization sequence in foreground mode (see Table 12).

Address: 0xce1		RW	Default: 0xbbe8
[7:0]	0xe8		Time allocated for calibration (see Table 12).
[8]	0x1		Enable calibration (see Table 12).
[9]	0x1		Enable foreground calibration (see Table 12).
[10]	0x0		Reserved.
[11]	0x1		Enable stg1 calibration (see Table 12).
[12]	0x1		Enable stg2 calibration (see Table 12).
[13]	0x1		Enable stg3 calibration (see Table 12).
[14]	0x0		Background calibration parallel mode (see Table 12).
[15]	0x1		Disable background calibration mode for all stages (see Table 12).

Preliminary

## ADC BRING-UP

The SD9629ET does not require a specific power-up sequence; however, it is recommended to apply the DRVDD first followed by the AVDD.

## Extended Temperature

To maintain full ADC performance over the extended temperature range, background calibration must be enabled. The registers in Table 16 must be programmed via the SPI interface:

Table 16. Background Calibration Enable.

Register Address	Value
[ADC_A_ADC_STG1_CAL4_register]	0xd80
0xccf	0xd80
[ADC_A_ADC_CAL_CTRL1_register]	0xfb80
0xce1	0xfb80
[ADC_A_ADC_CAL_CTRL2_register]	0x0
0xce3	0x0
0x809	0x18d4
0x80b	0x18d4

**ORDERING INFORMATION**

This product is protected by several U.S. Patents ([www.silannasemi.com/patents](http://www.silannasemi.com/patents)).

Preliminary

**PACKAGE DRAWING**

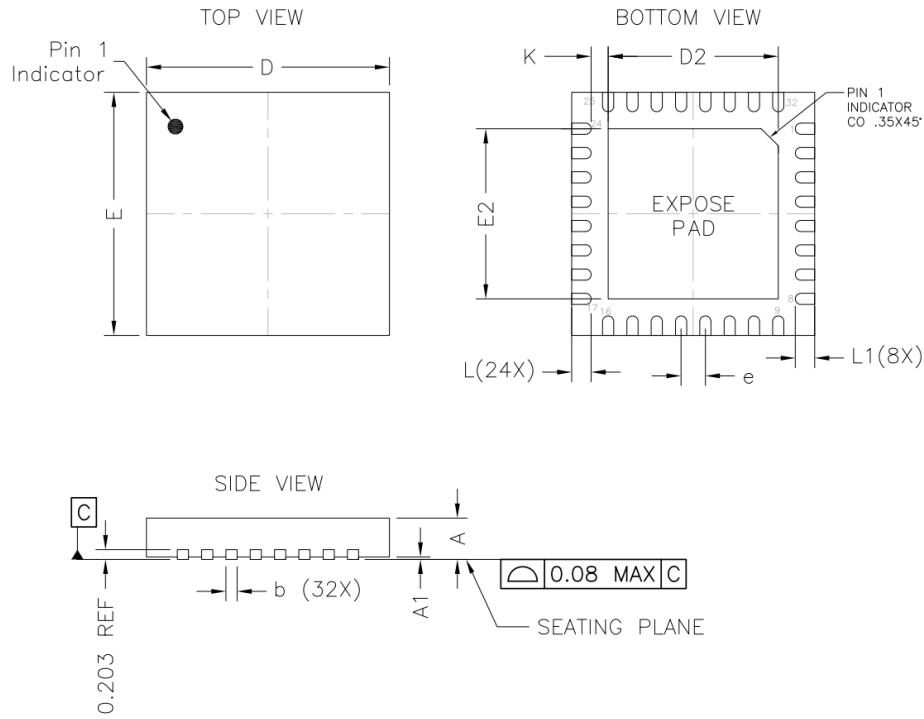

DIMENSION TABLE			
SYMBOL	MINIMUM	NOMINAL	MAXIMUM
A	0.70	0.75	0.80
A1	0.00	0.02	0.05
b	0.20	0.25	0.30
D	4.90	5.00	5.10
D2	3.45	3.50	3.55
E	4.90	5.00	5.10
E2	3.45	3.50	3.55
e	0.50 BSC		
L	0.35	0.40	0.45
L1	0.33	0.38	0.43
K	0.20	-	-
N	32		

- NOTE:
- Reference Doc: GRT Doc.: J1-10032-001-24 REV 24 QTY: 16/ 17  
Package Type: JEDEC OUTLINE-MO-220, Pack. Code WQFN(X532)  
PAD SIZE: B154X15\*MIL
  - Dimensioning and tolerancing conform to ASME Y14.5-2009.
  - All dimensions are in millimeters.
  - N is the total number of terminals.
  - Unilateral coplanarity zone applies to the exposed part as well as the terminals.
  - Lead Finish: 100% Sn.

Figure 25: Package Dimensions.

## APPENDIX A: Register Map

This section provides a comprehensive description of the complete register map, detailing all available control and status registers within the device.

### 0x400 - CHIP\_TOP

Address: 0x455		RW	Default: 0x0001
[0]	0x1		Soft reset (active low).

Address: 0x457		RW	Default: 0x0015
[0]	0x1		Duty Cycle Stabilizer enable (see [paragraph_DCS]). 0: Disable 1: Enable
[1]	0x0		Duty Cycle Stabilizer on/off in SPI mode (see [paragraph_DCS]). 0: Off 1: On
[2]	0x1		External output enable (OE/OEB) control (see [paragraph_OEB]). 0: Output Enabled 1: Output depends on pin OE/OEB
[3]	0x0		Output disable (see [paragraph_OEB]). 0: Output depends on OE/OEB control and OE/OEB pin 1: Disabled
[4]	0x1		MODE/OR pin function select 0: MODE 1: OR
[6:5]	0x0		Select MODE/OR pin function in SPI mode 00: Power down (default) 01: Stand-by 10: OE 11: OEB
[7]	0x0		Software power down. 0: Active State 1: Power Down
[8]	0x0		Software stand-by mode. 0: Active State 1: Stand-by Mode

Address: 0x45d		RW	Default: 0x0095
[0]	0x1		ADC reference voltage enable. 0: Disabled 1: Enabled
[4:1]	0xa		ADC reference voltage value. 0: Lowest ... 15: Highest
[5]	0x0		Set reference. 0: Internal 1: External from VREF pin
[11:6]	0x2		Reserved.
[12]	0x0		Enable selection between Internal and External VREF selection via bit 5. 0: Bit [5] selection disabled 1: Bit [5] selection enabled
[13]	0x0		Enable selection of VREF out via bit 14. 0: Bit [14] selection disabled 1: Bit [14] selection enabled
[14]	0x0		Enable VREF pin as reference voltage output. 0: Disabled 1: Enabled

Address: 0x463		RW	Default: 0x0019
[0]	0x1		Enable clock receiver. 0: Disable 1: Enable
[4:1]	0xc		Reserved.
[7:5]	0x0		Clock RX divider control. 0: Bypass 1: Divide by 2 2: Divide by 3 3: Divide by 4 4: Divide by 5 5: Divide by 6 6: Divide by 7 7: Divide by 8
[8]	0x0		Enable on-chip 100Ohm termination. 0: Disable 1: Enable
[9]	0x0		Clock polarity control when DCS is enabled. 0: Disable 1: Invert
[10]	0x0		Reserved.

Address: 0x465		RW	Default: 0x0001
[2:0]	0x1		Output data interleaver. 0-5: N/A 6: even-odd interleaving 7: odd-even interleaving

Address: 0x473		RW	Default: 0x0000
[4:0]	0x0		Reserved.
[9:5]	0x0		Output data delay in parallel CMOS mode. The output data delay is increased by 250ps * (register value) with respect to the clock
[13:10]	0x0		Reserved.
[14]	0x0		Output data sending clock polarity in parallel CMOS mode. 0: Not inverted 1: Inverted
[13:10]	0x0		Output clock delay. The output clock delay is increased by 250ps * (register value) with respect to the data
[14]	0x0		Output clock polarity. 0: Not inverted 1: Inverted

Address: 0x475		RW	Default: 0x0001
[0]	0x1		Enable VCM. 0: Disable 1: Enable

Address: 0x4b5		RW	Default: 0x18c0
[1:0]	0x0		Output format. 0: Offset binary 1: Two's complement 2: Gray code 3: Offset binary
[5:2]	0x0		Output test mode select (see Table 15).
[6]	0x1		Output test channel. 0: Disable 1: Enable
[7]	0x1		Reserved.
[8]	0x0		Output test toggle mode. Toggle between user test pattern 0 and 1.
[10:9]	0x0		Reserved.
[11]	0x1		PN9 generator reset (active low).
[12]	0x1		PN23 generator reset (active low).
[13]	0x0		Enable the output data scrambler. 0: Disable 1: Enable
[14]	0x0		Enable alternate bit polarity switch. 0: Disable 1: Enable

Address: 0x4b7		RW	Default: 0x0092
[15:0]	0x0092		PN9 initial seed.

Address: 0x4b9		RW	Default: 0x3aff
[15:0]	0x3aff		PN23 initial seed.

Address: 0x4bb		RW	Default: 0x0000
[15:0]	0x0000		User test pattern 0.

Address: 0x4bd		RW	Default: 0x0000
[15:0]	0x0000	User test pattern 1.	

Address: 0x4c9		RW	Default: 0x0000
[0]	0x0	Disable auto-recalibration. 0: Disable 1: Enable	
[15:1]	0x0	Reserved.	

Address: 0x4cf		RW	Default: 0x0035
[14:0]	0x35	Reserved.	
[15]	0x0	Disable production test mode. 0: Test mode enabled 1: Test mode disabled	

Address: 0x4fd		RO	Default: N/A
[2:0]		Chip revision.	
[6:3]		Label ID.	
[8:7]		Reserved.	
[10:9]		Resolution ID for device 0: 10-bit 1: 12-bit 2: 14-bit 3: 16-bit	
[13:11]		Speed ID for device.	

Address: 0x4ff		RO	Default: N/A
[0]		Reserved.	
[1]		Analog Supply Ready. 0: Not ready 1: Ready	
[2]		Digital Supply Ready.	
[3]		I/O Supply Ready. 0: Not ready 1: Ready	
[4]		Sense pin status.	
[5]		SPI enabled. 0: Not enabled 1: Enabled	
[10:6]		Reserved.	

### 0xF00 - ADC\_COMMON

Address: 0x809		RW	Default: 0x1800
[11:0]	0x800	ADC A channel gain. 0x000: 0.0 0x800: 1.0 0xfff: 2.0	
[12]	0x1	Enable ADC A path gain and offset.	

Address: 0x80b		RW	Default: 0x1800
[11:0]	0x800		ADC B channel gain. 0x000: 0.0 0x800: 1.0 0xff: 2.0
[12]	0x1		Enable ADC B path gain and offset.
Address: 0x80d		RW	Default: 0x0000
[15:0]	0x0000		ADC A channel offset. Signed 16-bit two's complement number.
Address: 0x80f		RW	Default: 0x0000
[15:0]	0x0000		ADC B channel offset. Signed 16-bit two's complement number.
Address: 0xf03		RW	Default: 0x07f9
[0]	0x1		Enable top level bias. 0: Disable 1: Enable
[2:1]	0x0		Reserved.
[3]	0x1		ADC enable. 0: Disable 1: Enable
[4]	0x1		Reserved.
[10:5]	0x3f		Mask for enable pin.
Address: 0xf05		RW	Default: 0x0030
[5:0]	0x30		Mask for stand-by pin.
[6]	0x0		Stand-by ADC. 0: Disable 1: Enable
[7]	0x0		Reserved.
Address: 0xf07		RW	Default: 0x0043
[0]	0x1		Digital clock enable. 0: Disable 1: Enable
[1]	0x1		Analog clock enable. 0: Disable 1: Enable
[5:2]	0x0		Reserved.
[6]	0x1		ADC clock generator reset (active low).
[7]	0x0		Reserved.
Address: 0xf11		RW	Default: 0x000b
[2:0]	0x3		Reserved.
[4:3]	0x1		VCM voltage control. 0: Lowest common-mode voltage ... 3: Highest common-mode voltage

### 0xCC1 - ADC

Address: 0xcc1		RW	Default: 0xbfff
[3:0]	0xf		Reserved.
[4]	0x1		Calibration soft reset (active low).
[15:5]	0x5f9		Reserved.

Address: 0xcc9		RW	Default: 0x06a5
[8:0]	0xa5		Reserved.
[9]	0x1		Stg1 enable background mode.
[11:10]	0x1		Reserved.

Address: 0xccd		RW	Default: 0x1483
[2:0]	0x3		Stg1 calibration convergence speed in foreground mode (see Table 12).
[11:3]	0x90		Reserved.
[13:12]	0x1		Stg1 calibration randomization sequence in foreground mode (see Table 12).

Address: 0xccf		RW	Default: 0x0d85
[2:0]	0x5		Stg1 calibration convergence speed in background mode (see Table 12).
[11:3]	0x1b0		Reserved.

Address: 0xcd1		RW	Default: 0x02a5
[0]	0x1		Stage 2 gain error calibration enable.
[1]	0x0		Stage 2 gain error calibration only.
[8:2]	0x29		Reserved.
[9]	0x1		Stg2 enable background mode.
[11:10]	0x0		Reserved.

Address: 0xcd5		RW	Default: 0x1483
[2:0]	0x3		Stg2 calibration convergence speed in foreground mode (see Table 12).
[11:3]	0x90		Reserved.
[13:12]	0x1		Stg2 calibration randomization sequence in foreground mode (see Table 12).

Address: 0xcd7		RW	Default: 0x0001
[2:0]	0x1		Stg2 calibration convergence speed in background mode (see Table 12).
[11:3]	0x0		Reserved.

Address: 0xcd8		RW	Default: 0x16c3
[2:0]	0x3		Stg3 calibration convergence speed in foreground mode (see Table 12).
[11:3]	0xd8		Reserved.
[13:12]	0x1		Stg3 calibration randomization sequence in foreground mode (see Table 12).

Address: 0xce1		RW	Default: 0xbbe8
[7:0]	0xe8		Time allocated for calibration (see Table 12).
[8]	0x1		Enable calibration (see Table 12).
[9]	0x1		Enable foreground calibration (see Table 12).
[10]	0x0		Reserved.
[11]	0x1		Enable stg1 calibration (see Table 12).
[12]	0x1		Enable stg2 calibration (see Table 12).
[13]	0x1		Enable stg3 calibration (see Table 12).
[14]	0x0		Background calibration parallel mode (see Table 12).
[15]	0x1		Disable background calibration mode for all stages (see Table 12).

Address: 0xce3		RW	Default: 0x0008
[2:0]	0x0		Reserved.
[3]	0x1		Clipping control to reserve some headroom for background calibration signals (active low).

Address: 0xceb		RW	Default: 0x0000
[0]	0x0		Calibration status. 0: Not done 1: Done
[7:1]	0x0		Reserved.

Address: 0xcef		RO	Default: N/A
[0]			Calibration complete.
[15:1]			Reserved.

## REVISION HISTORY

Version	Date	Comment
1.0	January 20, 2026	Initial Release.

Silanna Semiconductor Proprietary and Confidential

Information furnished by Silanna Semiconductor is believed to be accurate and reliable. However, no responsibility is assumed for its use. Silanna Semiconductor makes no representation that the interconnection of its circuits as described herein will not infringe on existing patents rights. Specifications subject to change without notice.

Preliminary